MOTORVAC
TECHNOLOGIES INC.

COOLANTCLEAN



Engine Cooling System Service

MANUAL #200-8232PL

Operator's Manual

Table of Contents

Introduction	3
Overview	4
System Features and Functions	1-1
Control Panel Features and Functions.....	1-1
Left View.....	1-2
Right View.....	1-3
Theory of Operation.....	1-4
Safety Information	2-1
Before You Begin	3-1
First Time Operation.....	3-1
Cooling System Service Procedure	4-1
Troubleshooting and Additional Help	5-1
Appendix A - Maintenance	A-1
Maintenance Procedures.....	A-1
Replacing the Unit's Filter.....	A-1
Maintenance Record.....	A-2
Appendix B - System Accessories	B-1
Included Adaptors.....	B-1
Optional Adaptors.....	B-2
Appendix C - Parts	C-1
Service Parts.....	C-1
Ordering Parts.....	C-1

Introduction

Congratulations on your selection of the CoolantClean3 Cooling System Service Unit. By choosing this product, you are acquiring the most technologically advanced method available for performing cooling system services and coolant exchanges.

The CoolantClean3 System is designed to service most automotive applications by exchanging virtually All of the coolant in the vehicle's cooling system. Connections to the vehicle are achieved with the supplied adaptors that install in-line between the vehicle's radiator & upper radiator hose.

Once connected, the unit can be safely used to:

- Relieve system pressure to provide safe, worry-free access to the vehicle's system.
- Pull down or evacuate the coolant levels in the radiator and overflow tanks, providing safe connection of the unit without hot coolant worries.
- Service the cooling systems by exchanging the coolant in the vehicle's system.

With the vehicle's engine idling, the CoolantClean3 unit receives used coolant flow from the vehicle's system through its RED hose and diverts the flow to an external waste container or to the shop's coolant disposal system. At the same time, new coolant flow to the vehicle will be supplied from the CoolantClean3's pump through the Green hose. When complete, the unit will automatically revert to a bypass or flow through mode alleviating the need to watch over the service.

It is recommended that vehicles (with conventional type coolant) have their cooling systems serviced every 15,000 to 30,000 miles, or according to the manufacturer's recommendations. Periodic service intervals are recommended to provide proper protection against overheating and breakdown of the coolant's protective properties. Old coolant can no longer protect against rust or acids that can breakdown metal & aluminum parts in the system.

Have all associated personnel study this Operators Manual completely to become thoroughly familiar the CoolantClean3 Cooling System Service Unit & it's proper operation.

IMPORTANT

**The CoolantClean3 Cooling System Service is designed to work
EXCLUSIVELY
With standard automotive coolant formulations.**

**Use of additives or chemicals during services may cause operational failure of
the CoolantClean3 Service System and will void the manufacturer's warranty.**

See the warranty card for specific details.

Overview

This manual contains all the information you need to use the CoolantClean3 Service Equipment. Please make sure all technicians using the unit & performing services read this manual and have it within easy reach whenever the unit is being used.

The following is a quick reference to the information in this manual.

System Features and Functions

This chapter describes the CoolantClean3 Service System's Controls, Switches, Lights, Connections and their proper usage.

Safety Information

Read & adhere to the safety guidelines in this chapter at all times!

Before You Begin

Follow the instructions in this chapter to prime the unit & check operation before using the CoolantClean3 unit for the first time.

Service Procedure

This chapter contains a step-by-step setup and service procedures for:

- Relieving system pressure
- Evacuating coolant in the radiator or overflow tank
- Performing a cooling system service.

Troubleshooting and Additional Help

Turn to this chapter in the unlikely event you have problems with CoolantClean3 service equipment or need additional help.

your

Appendices - Maintenance, Accessories, and Parts

The appendices contain routine maintenance procedures for the CoolantClean3 such as replacing the filter, lists of any available accessories & replacement parts.

System Features and Functions

The front of the Coolant Clean-III Cooling System Service unit contains the Control Panel, Fluid Filler Neck for adding coolant to the unit's Reservoir Tank & Tank Level Indicator. System overview and descriptions follow.

Front View - Control Panel Features and Functions

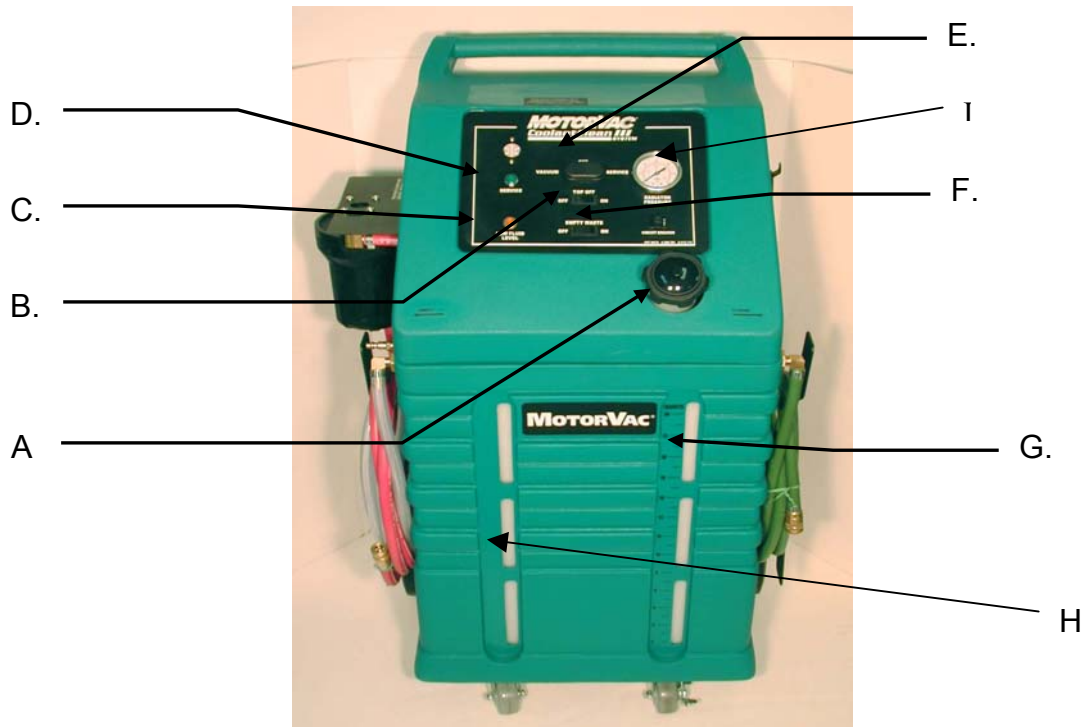

- | | |
|--|---|
| A. Reservoir Filler Neck | Access port to add coolant mixture to the unit's reservoir tank. |
| B. Top-Off Switch | Used to Top-Off / add coolant to the vehicle's system. |
| C. Amber "Low Fluid Level" Indicator Light | Upon completion of the service procedure.
Illuminates when the unit's reservoir tank has been depleted of coolant. |
| D. Green "Service in Progress" Indicator Light | Illuminates when the unit is in the SERVICE mode |
| E. 3 Position Power Switch:
<u>CENTER Position:</u> | Unit will be OFF / In By-pass mode (when connected to a vehicle) |
| <u>PRESSED TO LEFT:</u> | Activates the unit's VACUUM mode |
| <u>PRESSED TO RIGHT:</u> | Activates the unit's SERVICE mode |
| F. Empty Waste Switch | Used to empty the waste from 'capture' tank after service is completed. |
| G. Clean Tank Level Indicator | Indicates the coolant mixture level in unit's reservoir tank. |
| H. Waste tank level indicator | Indicates the used fluid level in the capture tank. |
| I. Output pressure gauge | Indicates system pressure during service. |

Left View

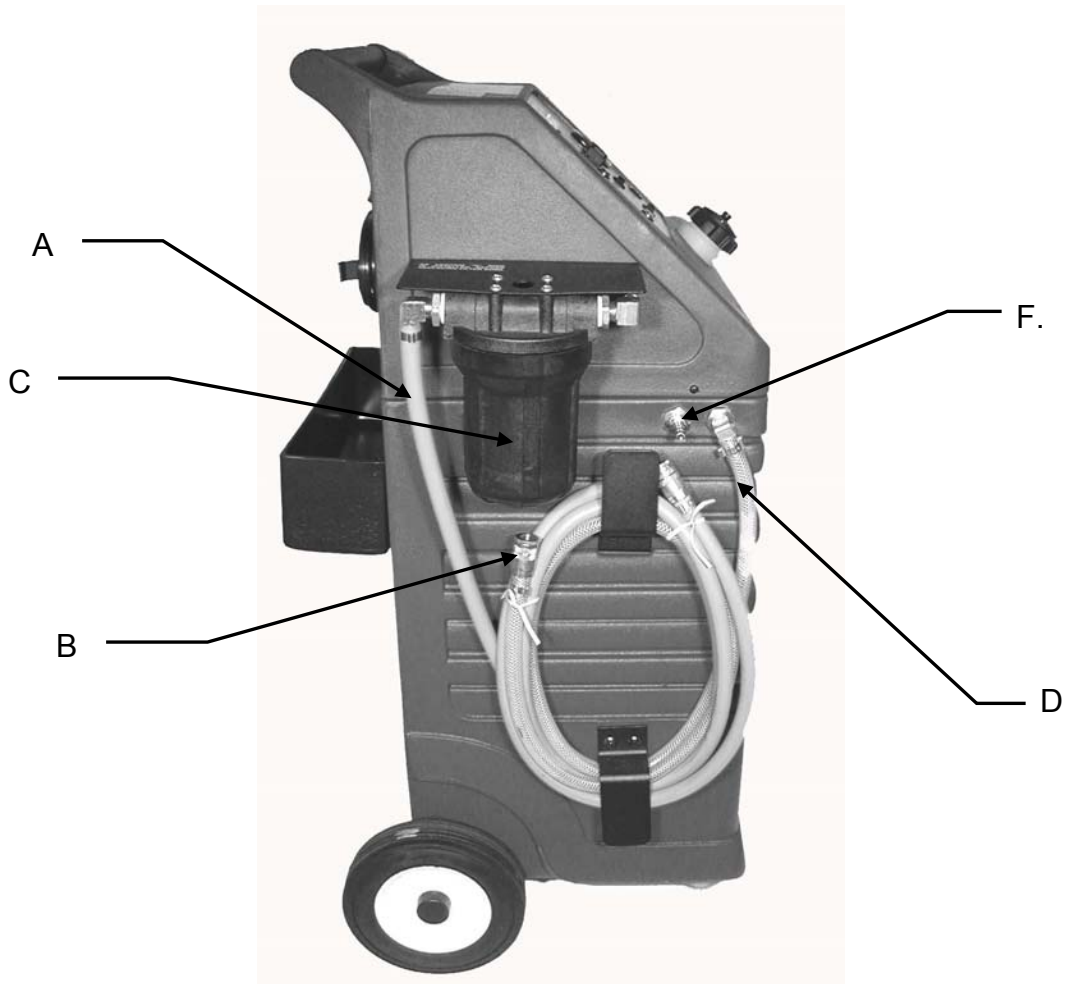

A. RED / Used Coolant Service Hose

- ◆ Receives used coolant from the vehicle when connected
- ◆ Used to evacuate the vehicle's coolant in the vacuum mode

B. Quick Coupler

Secures the needed adaptor to the unit's service hose.

C. Filter Assembly

Stainless Steel 50 Mesh Screen for used coolant filtration.

D. Clear Braided Disposal Hose

Inserts into the shop's coolant recycling system or collection tank for proper disposal of used coolant.

E. Waste Tank Access nipple.

Used for capturing waste fluid during services.

Right View

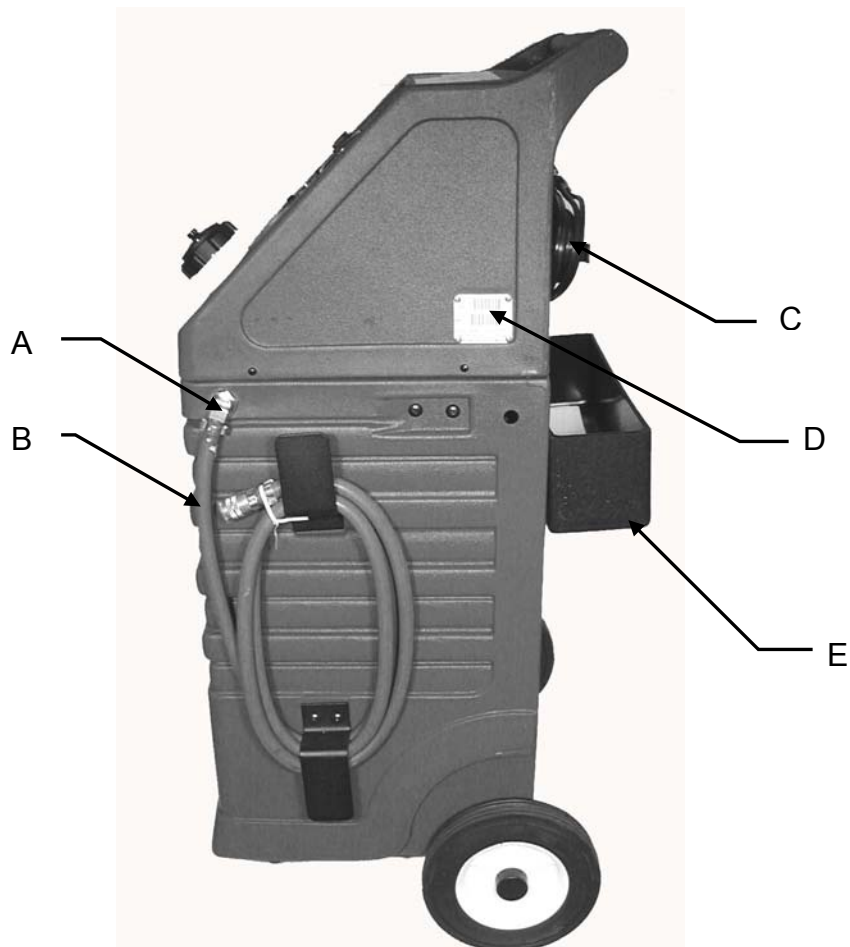

A. Quick Coupler

Secures the needed adaptor to the unit's service hose.

B. GREEN / New Coolant Service Hose

- Provides NEW coolant to the vehicle during services.
- **Adds coolant to the vehicle in the "top-off" mode.**

C. Battery Cables

Positive (Red) & Negative (Black) battery connections

D. Serial Number Tag

Model & Serial number label.

E. Adapter Tray

Storage tray for adapters.

Theory of Operation

Detailed descriptions of the various operations, switches and indicators that make up the Coolant Clean-III's control panel are listed below.

3- Position Power Switch:

◆ **When the main power switch is in the OFF position (CENTER):**

- (And unit connected to an operating vehicle) The unit will be in a flow through or "by-pass" mode. At this time, coolant flow from the vehicle passes through the unit and returns to the vehicle.
- The OFF position will also disable the unit's audible, low-level alarm (if activated). At this time the "Top-off" feature will be operational until the unit has been disconnected from power.

◆ **When the main power switch is pressed to the VACUUM position (LEFT):**

The Coolant Clean-III's vacuum pump and 2-way solenoid will activate simultaneously and apply vacuum to the system being serviced. In VACUUM mode, used coolant will be pulled from the vehicle through the unit's RED / vacuum hose, passing through the unit's filter screen assembly then exhausted from the unit through the CLEAR BRAIDED disposal hose (which should be inserted into the shop's coolant recovery system or connected to the waste tank 'nipple' of the Coolant Clean-III's waste capture tank.).

◆ **When the main power switch is pressed to the SERVICE position (RIGHT):**

The Coolant Clean-III's Green "service in progress" indicator will illuminate, the pressure pump and the vacuum pump will activate simultaneously supplying new coolant from the reservoir tank, through the pressure pump and to the vehicle being serviced through the unit's GREEN / new coolant hose. At this time, the vehicle's used coolant flow will be routed to the unit through the unit's RED / used coolant hose & exhausted from the unit through the CLEAR BRAIDED disposal hose (which should be inserted into the shop's coolant recovery system or connected to the unit's waste capture tank 'nipple').

2-Position On-Off Switch: (Top-Off function)

◆ **When activated, this feature will:**

- Disable the unit's Amber "Low Fluid Level" indicator (If illuminated).
- Override low-level "by-pass" mode to provide additional coolant from the unit's reservoir to top-off the vehicle's cooling system anytime the unit is connected to power. Coolant will be provided through an open-ended adaptor connected to the unit's GREEN / new coolant hose.

Empty waste switch: Used to drain- (empty) the waste fluid capture tank. Note: Hoses must be switched before "draining". The clear-braided waste hose must be disconnected from the waste tank nipple and an adaptor inserted into it's coupler. Direct the clear hose into the shops waste tank. Hook up the RED hose coupler to the waste tank "nipple". Then activate the empty waste switch. Pump should stop automatically when waste tank is empty.

Fluid Level Switch:

- ◆ Will activate the unit's Low Fluid Level warning system when the coolant level in the reservoir has reached its minimum fluid level. (zero level) At this time the unit's pumps will stop, the amber panel mounted "Low Fluid Level" indicator light illuminates, the audible low-level alarm will sound & the unit will automatically revert to a flow through or "bypass" mode.

NOTE: Moving the power switch to the OFF position (CENTER) will disable the unit's Low Level alarm (but *will not* disable the Amber, "Low Fluid Level" indicator light).

The "Top-Off" feature will be operational anytime the unit is connected to power.

Safety Information and Precautions

/!\ DANGER

Vehicle exhaust gases contain Carbon Monoxide, which is a colorless and odorless lethal gas.

Only run engines in well-ventilated areas and avoid breathing exhaust gases.

Extended breathing of exhaust gases will cause serious injury or death.

/!\ WARNING

Exhaust gases, moving parts & hot surfaces are present during and after the vehicle's engine is running.

Hot coolant is present during the connection of the service equipment.

Read and understand the operator's manual before using the CoolantClean3 Service System.

When using petroleum products or chemicals always refer to the MSDS sheets and manufacturer's instructions for the proper procedure to handle emergency medical treatment, cleanup, handling and storage requirements.

Improper use of the CoolantClean3 Cooling System Service equipment or exposure to exhaust gases and hot coolant can cause injury.

Spilled coolant on an engine can ignite.

Avoid exposure to flames, sparks, hot engine parts, and other ignition sources.

Always keep a fully charged fire extinguisher nearby. All extinguisher should have a class "B" rating suitable for gasoline, chemical and electrical fires.

Cleanup any oil or coolant spills immediately.

Dispose of contaminated cleanup material according to governing environmental laws.

Never look directly into the air plenum or carburetor throat when the engine is operating.

Always verify hose connections are secure to the radiator, upper hose & other connection points before starting the vehicle's engine. Pressure test if necessary.

Explosion or flame or exposure to flammable liquid and vapors can cause injury.

Flammable coolant can splash out of the unit's tank when filling or when unit is being moved.

Always keep unit's coolant tank cap secure except when filling with coolant.

Explosion or flame can cause injury.

Engine cooling systems may maintain residual pressure in connection lines to and from the radiator even after the engine has been turned off.

Wear safety goggles.

Wear chemical resistant gloves when connecting or disconnecting hoses and adapters.

Chemicals can cause harmful byproducts and undesirable effects on the unit,

Do not add any chemicals to CoolantClean3's reservoir tank.

Use only approved coolants.

Do not swallow or ingest any chemicals.

Use with adequate ventilation. Avoid breathing vapors.

Do not store or use chemicals in or on the machine (other than coolant).

Improper use of coolant can cause injury.

Over exposure can have harmful effect on eyes, skin, respiratory systems & possible unconsciousness or asphyxiation.

Improperly blocked vehicles can move.

Set the parking brake and chock the wheels.

Moving engine parts:

The engine cooling fan may cycle on and off depending on the coolant temperature and could operate without the engine running.

Wear safety goggles.

Always keep objects, clothing, and hands away from the cooling fans and engine parts.

Moving engine parts can cause injury.

Hot surfaces are present during and after running the engine.

Do not contact hot surfaces such as manifolds, pipes, mufflers, catalytic converters, Radiators, hoses, adapters or other hot parts of the cooling system.

Hot surfaces can cause injury.

Catalytic converters become extremely hot.

Do not park converter-equipped vehicle's over dry grass, leaves, paper or other flammable material.

Do not touch a catalytic converter until the engine has been off for at least 45 minutes.

Catalytic converters can cause burns.

Cracked fan blade can become airborne.

Examine fan blades for cracks. If found, do not service the vehicle.

Flying objects can cause injury.

Batteries produce explosive gases and can explode.

Wear safety goggles when working on or near batteries.

Use in a well-ventilated area.

Keep sparks and flames away from the battery and never lay tools, equipment or other conductive objects on the battery. When connecting tools or equipment to a power source battery, assure the equipment's power switch is OFF. Connect the positive lead of the equipment to the positive battery lead first connect the negative lead equipment to a solid ground point as far from battery as possible.

Keep battery acid away from skin or eyes. In case of eye contact, flush with clean water for 15 minutes and get medical attention.

Battery explosion and ignited gases can cause injury.

Before You Begin

First Time Operation

NOTE:

This unit has been tested with water and is ready for use after receiving the unit & performing the following priming procedure.

Remember to send in your warranty card to properly register your machine.

1. Check the unit's service hoses, battery connections and all external components for damage.
2. Attach the unit's power harness to the vehicle's battery by connecting the red battery clip to the positive (+) battery terminal and the black (-) clip to a solid ground point as far from the battery as possible.
3. Turn the external spin-on filter canister to tighten.
4. Fill the unit's reservoir with a minimum of 12 quarts (11 liters) of **new coolant mixture. CAUTION, DO NOT MIX DEXCOOL WITH ETHYLENE GLYCOL TYPE COOLANT. RESULTS WILL "JELL".**
5. Connect the open-ended adaptor P/N # 060-1400 to the unit's RED / Vacuum hose.
6. Insert the RED hose (with the open ended adaptor attached) into the unit's reservoir filler neck & into the tank assembly until it reaches the coolant mixture level.
NOTE: Assure the adaptor end remains *below* the coolant level during this procedure.
7. Connect the clear braided waste hose to the waste tank nipple.
8. Press the unit's 3 way Power Switch to the VACUUM position (LEFT) & let unit run until there is a continuous flow in the clear braided disposal hose without any air bubbles present. Move power switch to the OFF position (CENTER) & remove adaptor from RED hose.
9. Install an open-end adapter in the GREEN hose coupler and direct the hose back into the clean fluid tank. Press the unit's Top-Off switch to ON and let it run until there is continuous flow of fluid from the green hose. Move Top-Off switch to the OFF position. Move power Switch to the CENTER/OFF position. Before disconnecting hoses, momentarily run vacuum pump to relieve pressure.
10. The unit is now ready to perform a service. See service instructions for procedure.

NOTE:

This procedure must be performed BEFORE operating the unit for the first time or any time the unit's reservoir tank is completely emptied.

Engine Cooling System Service Procedure

Follow this section to connect the CoolantClean3 unit to the vehicle's radiator & upper radiator hose. Make sure the vehicle has at least 1/8 tank of fuel before beginning this process.

IMPORTANT

Do not perform the engine cooling system service if the vehicle's engine or transmission oil level is low.
If necessary, add motor oil and/or transmission fluid.

!! WARNING

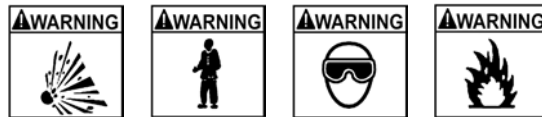

Verify that engine and machine are both off before connecting or disconnecting radiator hoses, lines or adapters.

Hot Coolant can spray out of pressurized lines when connecting or disconnecting.

Always wear safety goggles.

Wear chemical resistant gloves when connecting or disconnecting hot fittings and adapters.

Wrap a shop towel around pressurized fittings and adapters when disconnecting.

Avoid exposure to flames, sparks, hot engine parts, and other ignition sources.

Explosion or flame or exposure to flammable liquid and vapors can cause injury.

Service Procedure

1. Check engine & coolant temperatures before removing any cooling system components or repairing any associated items, let vehicle cool off if necessary.
CAUTION: Cooling systems may retain residual pressure after the vacuum procedures are performed. Extreme care should be taken and proper protection worn when releasing the radiator and overflow tank caps. **Verify all pressure has been alleviated before opening hot cooling systems; hot coolant under pressure can cause severe burns.**
2. Attach the unit to the vehicle's battery by connecting the unit's red battery clip to the positive (+) battery terminal and the black battery clip to a solid ground point as far away from the battery as possible.
3. Connect the clear braided disposal hose from the machine to the waste tank nipple or install an adapter and direct into the shop's coolant recycling receptacle or into a suitable container approved for hot coolant collection.
4. Locate and carefully remove cap from the coolant overflow tank (if applicable). Attach an open-ended adaptor onto the unit's RED / used coolant hose & insert adaptor end into overflow tank. Press the unit's power switch to the VACUUM position (LEFT) & evacuate approximately half of the amount of coolant in the overflow tank. Move unit's power switch to the OFF position (CENTER) to stop the vacuum pump.
5. Locate and carefully disconnect the vehicle's overflow tank hose (The overflow hose is usually located on the radiator filler neck, just under the radiator cap). Connect the adaptor on the unit's RED hose to the radiator overflow nipple (Use the proper size hose piece and stepped fitting if necessary).
6. Press the unit's power switch to the VACUUM position (LEFT).
7. Slowly and carefully pull the pressure release lever on top of the radiator cap (if applicable) or loosen radiator cap according to the vehicle's manufacturer or the instructions printed on the top of the radiator cap. Carefully remove cap from radiator.
8. Disconnect RED vacuum hose from radiator overflow tube, insert hose into radiator fill neck & evacuate until the coolant is below the upper radiator hose connection point.
9. Remove RED vacuum hose from radiator & re-insert into overflow reservoir, evacuate container completely. When finished, press power switch to the OFF position (CENTER).
10. Disconnect vehicle's upper radiator hose and install the correct size adapters to radiator and to the removed upper hose. Tighten hose clamps securely.
11. Connect the unit's service hoses to the vehicle: **FOR SERVICE WITH ENGINE RUNNING.** The unit's GREEN / new coolant hose will connect to the adapter installed on radiator's upper inlet and the unit's RED / used coolant hose will connect to the adapter installed on the upper radiator hose (previously removed from the radiator).
NOTE: In some cases, vehicles with reverse flow characteristics may require that the unit's service hoses (RED & GREEN) be reversed. *Verify flow before connection of unit and hose.*
12. Verify that the Coolant Flush's tank contains the correct amount of Antifreeze (Coolant) and water mixture. (Refer to the coolant and/or vehicle manufacturer's specifications for proper mixture ratios)

Service Procedure, (Continued)

13. Press the unit's power switch to the SERVICE position (RIGHT). Continue until the coolant level has reached the middle of the radiator filler neck. When the proper level is reached press the unit's power switch to the OFF position (CENTER) to stop unit. *Re-install radiator cap securely.* Start vehicle's engine & press the unit's power switch to the SERVICE position (RIGHT).
14. With engine running, continue with the service until the coolant in the unit's tank has been depleted or until the coolant draining from the clear braided drain hose is clean. When either one of these conditions have been met, press the unit's power switch to the OFF position (CENTER) to stop unit. **NOTE: If the upper radiator hose is collapsing during the service or the overflow reservoir is being drained, increase the engine rpm.** This increases the flow thru the vehicles' water pump assembly.
Turn off vehicle's engine at this time.

NOTE: When the unit's tank has been depleted of fluid a low level light will illuminate & the low level alarm will sound. At this time the unit automatically reverts to a "bypass" mode and the vehicle's cooling system flow will simply pass through the unit and return to the vehicle in a closed loop fashion. Turning off the unit will disable the audible warning.
15. Remove the clear braided drain hose from the waste tank nipple or shop's waste tank or receptacle and insert an adapter and direct it into the vehicle's coolant recovery tank. Press unit's power switch to the VACUUM position (LEFT) to fill the recovery tank. When recovery tank has reached the proper or acceptable fluid level, press the unit's power switch to the OFF position (CENTER). **NOTE:** This step will also alleviate any residual pressure remaining in the system to provide safe disconnection of the unit's adaptors and connections when the service is complete.
16. Verify that the unit's pressure gauge reads, "zero". Carefully remove the radiator cap. Coolant level should be lower than the upper radiator hose connection point. If level is not acceptable insert the unit's clear braided hose into a suitable collection container. (See note). Continue with power switch in the VACUUM position (LEFT) until coolant level is acceptable. **NOTE:** During this procedure, the clear braided hose will be draining clean coolant from the vehicle. You may choose to save this "clean" coolant in an acceptable storage container for future use or direct the flow into the shop's waste receptacle.
17. Disconnect unit's lines & adaptors from vehicle and re-connect vehicle's upper radiator hose and overflow tank hose. Tighten hose clamps securely and inspect connections with system pressurized.
18. Re-connect an open adapter to the unit's GREEN / new coolant hose & insert hose into the vehicle's radiator filler neck, press the unit's TOP OFF button to the ON position to fill or top-off the coolant in the radiator. Repeat procedure to fill or top-off the radiator overflow tank. Adjust radiator and overflow tank levels as per manufacturer's specifications.
19. Start engine with radiator cap removed. Re-check and adjust radiator & overflow tank levels as needed. Replace radiator cap securely when procedure is complete.
20. To empty the waste fluid tank you must **switch** the hose connections at the waste tank Nipple. Disconnect the clear-braided hose and put an adapter into the coupler. Direct the clear hose into the shops waste container. Connect the **RED** hose coupler to the waste tank nipple. Turn on the empty waste switch. The pump should stop when the tank empties.

OPTIONAL SERVICE PROCEDURE.

To complete a service with the engine OFF, simply reverse the green and red hose connections. The green hose will go to the upper radiator hose adapter and the red hose will go to the adapter on the radiator.

Press “Service” and unit will transfer fluid until clean fluid tank is empty or “Service” switch is turned off.

When doing an “Engine Off” exchange it is normal for the Clear-braided waste hose to have air bubbles (SPITTING is caused by no vehicle pump action and the CoolantClean3’s vacuum pump is drawing down the upper radiator tank). The actual exchange will take a little longer than with the engine running, but there will be no chance of overheating the vehicle.

Vehicles with vacuum controlled heater valves may not flush the heater in “Cold engine” Mode.

WARNING:

DO NOT MIX DEXCOOL & ETHYLENE GLYCOL BASED FLUIDS!!! Gelling will occur!!
Flush vehicle and or CoolantClean3 with water between usage of these fluids. If you are changing the Dexcool in a vehicle to ethylene glycol, flush the vehicle with water prior to introducing the ethylene glycol.

Troubleshooting and Additional Help

Refer to the list below in the unlikely event that you have problems with your **CoolantClean Engine Cooling System Service Unit**.

Problem:

Solution:

1. **The unit's light is lit but no other functions are available from the control panel switches.**

Polarity is reversed on vehicle battery connection, correct as necessary.
2. **Unit's pump starts but does not supply coolant (no pressure or very low pressure on the gauge).**
 - a. Unit's pressure pump needs to be primed. See: **Before You Begin** section
 - b. Internal screen filter (top of clean fluid tank) or siphon tube may be plugged up.
 - c. 10 psi control check valve may be stuck open. (Dumps fluid back into clean tank).
3. **Vacuum pump is running but there is no suction from the red hose.**

Check the external filter for a clogged condition. Clean if necessary.
"By-pass" check valve may be stuck open allowing suction into the clean fluid tank. Waste hose must be connected to allow "outflow".
4. **Vehicle and machine are both running but there is no flow to the drain hose.**

Check connection of unit's hoses to adapters. Engine may need to be accelerated. Verify engine's temperature, vehicle may be too cold and thermostat may be closed.
5. **The unit's pressure gauge is at 10 to 15 psi. And there is no flow to the drain hose.**
 - a. Check for kinked condition on Green Hose. Connections to the vehicle may need to be reversed. Check vehicle's flow direction & re-connect hoses if necessary.
 - b. Check external filter for blockage.
6. **The unit performs poorly.**

Check all hoses and wires for cuts or frays. Check cabinet for dents or impact markings. Verify that the inter filter screen and external filter have recently been cleaned. (Refer to the maintenance log in **Appendix A** to view dates of services).

ADDITIONAL HELP

Please verify that items 1-6 above have been reviewed before calling for additional assistance.

In the unlikely event that problems persist with the unit, call **Technical Support**. Have your model and serial numbers available before you call. Remember to send in your warranty card.

In the U.S.
(714) 558-4822
(800) 841-8810

International:
Call your local
distributor

MACHINE OPERATION - CHECK OUT PROCEDURE:







1. Check unit's fittings, electrical connectors, hoses, nuts, screws, and overall general condition for proper assembly and position.
2. Verify coolant mixture level on the unit's level sight window. If no fluid is visible, connect unit's battery leads to power supply, verify that the LOW FLUID LEVEL light and the alarm are activated; sound of alarm should be loud and clear. Disconnect from power. If fluid is above 4-quart mark, continue with step 4.
3. Remove fuel tank filler cap, add a minimum of 6 quarts of coolant mixture (or water). Re-connect power to unit, verify that the low level alarm and light have turned off automatically.
4. Connect an adapter to the RED hose (Used Coolant / Vacuum hose). Insert the hose into the unit's coolant tank until the adapter is submerged. Insert an adapter into the unit's clear braided disposal hose coupler and direct into the unit's coolant tank or into a suitable container for temporary storage of antifreeze coolant mixture. Verify that the GREEN, (New Coolant supply) hose, is not connected to an adapter.
5. Press the Power switch to VACUUM position. Verify that vacuum pump runs and that it pulls 20 inch's vacuum and good flow out of the drain hose, (Vacuum gauge not part of the machine). If flow is not good, check external filter for a clogged condition.
6. Disconnect the adapter from the Red hose and install it onto the Green hose. Direct hose into the measured container. Press the power switch to the SERVICE side, verify that coolant mixture flow is minimum of One Quart, (1-qt.), per 15 seconds @ 5-6 psi on the unit's pressure gauge.
7. Connect both Green Output/ Red Return Hoses together using two compatible step adapters and a hose secured with a hose clamp.
8. Kink the Green hose then press the Power switch to the SERVICE position. Release kinked hose, verify that the unit's pump runs and coolant flows out through Drain hose into the unit's tank (or container). Kink green hose then press Power switch to OFF position.
9. Press the power switch to the VACUUM position, let run until no pressure is shown on the pressure gauge.
10. Separate hoses. Connect an open-end adapter onto the Green hose, direct hose into a suitable clean container for temporary storage of coolant mixture.
11. Let pump run until the low level alarm and light are activated; verify that the pump stops automatically.
12. Press the power switch to the OFF position, verify that the alarm stops but the amber low level light remains illuminated.
13. Press the TOP OFF switch to the ON position. Verify that the system overrides the low level condition by activating the unit's supply pump & turning off the amber low-level indicator light.
14. Remove adapters. Disconnect battery leads. Roll up hoses on brackets. Check internal connections and clean interior.
15. Reinstall unit's back panel and update unit's maintenance & repair log.







Appendix B – System Accessories

Basic Adaptor Kit: 200-3106

CoolantClean Engine Cooling System Service Unit

The following is a list of the adaptors included with your CoolantClean unit.

PART & NUMBER	QTY	DESCRIPTION
 <p data-bbox="634 520 760 552">063-1030</p>	1	<p data-bbox="979 474 1325 600">Stepped Hose Adaptor 1 1/4" x 1 1/2" OD (Engine Side)</p>
 <p data-bbox="634 730 760 762">063-1031</p>	1	<p data-bbox="979 703 1211 829">Plug Adaptor 1 1/4" x 1 1/2" OD (Radiator Side)</p>
 <p data-bbox="634 1005 760 1037">063-1032</p>	1	<p data-bbox="979 953 1325 1079">Stepped Hose Adaptor 1 3/4" x 2" OD (Engine Side)</p>
 <p data-bbox="643 1262 768 1293">063-1033</p>	1	<p data-bbox="979 1209 1211 1335">Plug Adaptor 1 3/4" x 2" OD (Radiator Side)</p>
 <p data-bbox="643 1499 768 1530">080-6005</p>	2	<p data-bbox="979 1482 1162 1566">Hose Clamp #28</p>
 <p data-bbox="638 1780 763 1812">010-5408</p>	2	<p data-bbox="979 1787 1162 1871">Hose Clamp #36</p>

PART & NUMBER	QTY	DESCRIPTION
 <p data-bbox="435 348 558 380">060-1400</p>	1	5/16" Open End Adaptor
 <p data-bbox="634 485 760 516">030-4404</p>	1	1/4" x 3/8" Union Step Cone
 <p data-bbox="634 758 760 789">070-0120</p>	1	3/8"ID x 4"lg Rubber Hose
 <p data-bbox="672 989 797 1020">070-0126</p>	1	1 1/4"ID x 4"lg Rubber Hose
 <p data-bbox="672 1199 797 1230">070-0127</p>	1	1 1/2"ID x 4"lg Rubber Hose
 <p data-bbox="672 1430 797 1461">070-0128</p>	1	1 3/4"ID x 4"lg Rubber Hose
 <p data-bbox="672 1692 797 1724">070-0129</p>	1	2"ID x 4"lg Rubber Hose

OPTIONAL LARGE TRUCK ADAPTOR KIT 200-8803

PART & NUMBER	QTY	DESCRIPTION
 <p>063-1034C</p>	2	Hose Adaptor 2 ¼ x 2 ½ x 3 dia
 <p>070-2000</p>	1	Hose 2 ¼ ID x 5" Long
 <p>070-2001</p>	1	Hose 2 ½ ID x 5" Long
 <p>070-2002</p>	1	Hose 3" ID x 5" Long
 <p>080-7000</p>	2	Hose Clamp 2 ¼ to 2 ½

	080-7001	2	Hose Clamp 2 ½ to 3 ½
---	-----------------	----------	--

ORDERING PARTS

**Parts for the unit may be ordered by calling
Customer Service, have your model and serial numbers available:
Call: 800.841.8810, 714.558.8810**

Appendix A - Maintenance

Maintenance Procedures

The following maintenance procedures should be performed on a routine basis:

1. Clean unit's internal filter screen every 30 services or as necessary. Located on top of the clean fluid tank.
2. Clean the unit's external filter screen every 15 services or as necessary. See the next section for procedure.
3. Carefully clean the exterior with a soft cloth to keep the cabinet looking new. Check the cabinet for dents or impact markings, if found inspect for damaged components.
4. Check all hoses and wires for cuts or frays.

Cleaning The Unit's External Filter

CAUTION!!! Filter, unit components and coolant may be HOT.

NOTE: Carefully touch the RED hose to determine component temperatures before unscrewing filter or performing any service procedures.

1. Connect unit to a 12 VDC. Automotive battery.
2. Insert the unit's Clear Drain hose to into a suitable container for proper disposal of antifreeze.
3. Connect an open-end adapter to unit's Red hose, press power switch to VACUUM position.
4. Let pump run until no fluid is draining from the unit's drain hose. Press switch to OFF.
5. Place a catch pan under the filter assembly to collect any coolant spills.

J. Cleaning the unit's Filter:

1. Remove filter canister by turning clockwise.
Carefully remove internal screen for cleaning, Clean screen carefully, (do not deform). To reinstall, align screen on tapered alignment bezel in center of canister. Verify that screen stands in center of canister, verify that o-ring seal is installed correctly & reinstall canister carefully to avoid deforming screen.
2. Enter initials, date, and a check mark in the appropriate boxes of the Maintenance Record at the end of this chapter.

Appendix C - Parts

Service Parts: CoolantClean Engine Cooling System

Please refer to the part numbers below when ordering parts for the unit.

<u>Part #</u>	<u>Description</u>
010-0027	Wheel
010-0026	Hub cap
010-6100	Swivel caster
010-6101	Swivel caster with break lock
010-5500	Axle, 1/2" Diameter, (Rear wheels)
040-0604	Cap Nut, 1/2" ID
040-0507	Axle bushing 1/2" ID. (Plastic)
010-5004	Hose bracket
010-6060	Reservoir cap
010-5602	Adapter box
010-1052	Bottle for adaptor box
040-1200	Screw, Phillips, 6-32 x 1/2" SS. (Adapter box)
040-2000	Threaded standoff, 6-32 x 3/8 Al. (Adapter box)
040-2200	Flat washer, #6 orifice, SS (Adapter box)
020-1003	Harness, power
020-0038	circuit breaker 15 AMP
020-0067	Lamp, amber 1/2" mount
020-0073	Lamp, green 1/2" mount
020-1200	3- Position ON/OFF rocker switch
020-1205	2- Position ON/OFF switch (top-off & empty waste)
040-6023	Screw, Phillips head, #8 x 3/4" blk (Control & Rear panel)
080-0236	Female Quick Disconnect Couplers, 1/4", Brass
050-1935	Filter-Screen (external canister insert)
200-8701	Output hose assembly, (Green)
200-8702	Return hose assembly, (Red)
200-8703	Disposal hose assembly
200-8232PL	Operators Manual
200-3106	Adapter Kit, (Complete)