

# COATS

# 310



## OPERATING INSTRUCTIONS

READ INSTRUCTIONS THOROUGHLY BEFORE USING MACHINE

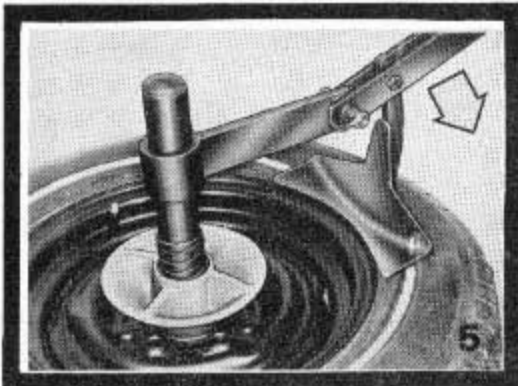
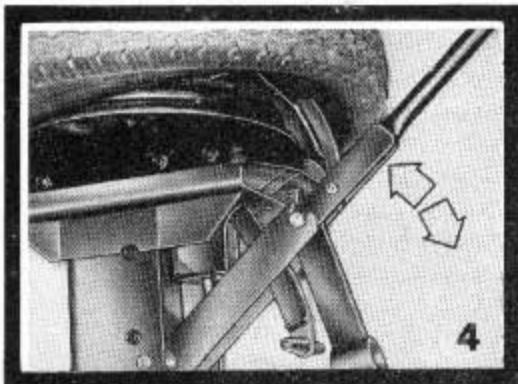
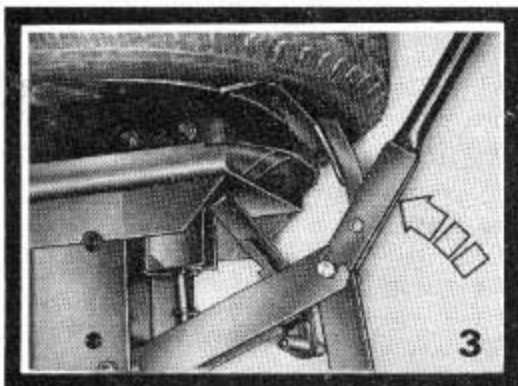
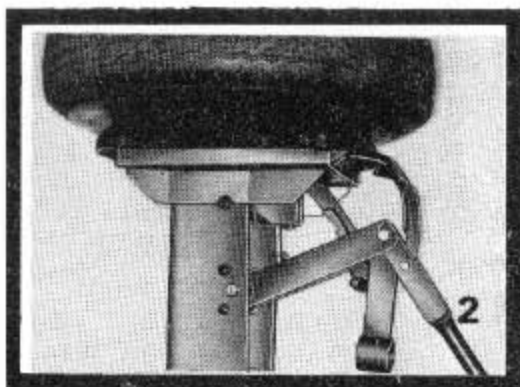
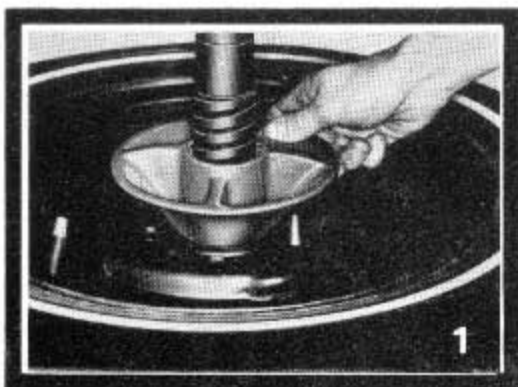

### BEAD LOOSENING OPERATION LOOSEN BOTTOM BEAD FIRST!

- Step 1. Remove the core from the tire valve and allow the pressurized air to escape.
- Step 2. Place the tire and wheel assembly on the contoured table top with the narrow side of bead seat up. Be sure the positioning pin is through one of the lug holes of the wheel. Thread the hold down cone clockwise on the center post. See Fig. 1.
- Step 3. With the bead loosener support in the lowest ratchet position, place the combination bead loosener assembly in position as shown in Fig. 2.
- Step 4. Rotate the handle of the combination bead loosener upward. This operation will begin to move the lower bead of the tire toward the drop center of the wheel rim. See Fig. 3.
- Step 5. Rotate the handle of the combination bead loosener downward. This will allow the support bracket to ratchet upward. Again, rotate the handle upward. This mechanism permits the bead loosener additional stroke in forcing the bead to the drop center of the wheel rim. See Fig. 4.

### LOOSENING TOP BEAD

- Step 6. Remove the bead loosener assembly from the lower support bracket and place the tube end over the center post. Exert pressure downward on the handle, then let up on handle to allow loosener arm to lower on center post to obtain greater leverage. After initial attempt on stubborn tires, move to left or right and repeat until bead is loosened. See Fig. 5.

## TIRE REMOVING OPERATION

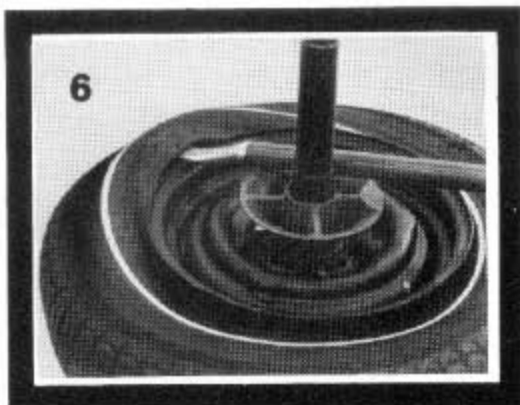

1. Always apply lubricant to both top and bottom beads

2. Push top bead down into drop center of the rim and reach across wheel and insert take-off end of the combination tool under top bead. Lower handle as shown in Fig. 6.

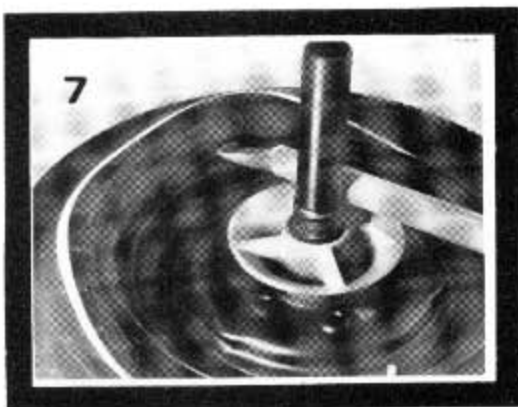

3. Move hands to opposite end of tool and pull tool in clockwise direction until the entire upper bead is above rim. (See Fig. 7)

Note: If tire contains a tube, take out the tube before removing the bottom bead.

4. With top bead above the rim, lift and push bottom bead into drop center of rim. Reach across wheel and insert Take-Off end of Tool under bottom bead.

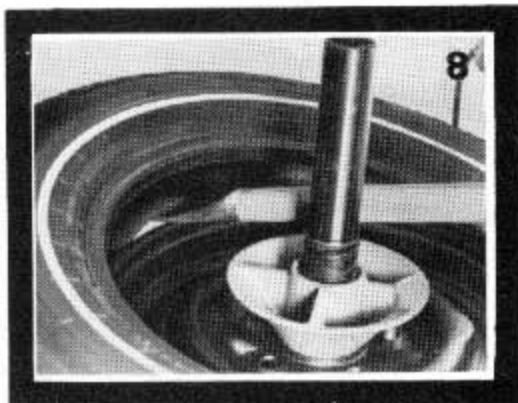

5. Lower handle extension as shown in Fig. 8.

6. Move hands to opposite end of tool and pull tool in clockwise direction to remove tire.

## TIRE MOUNTING OPERATION

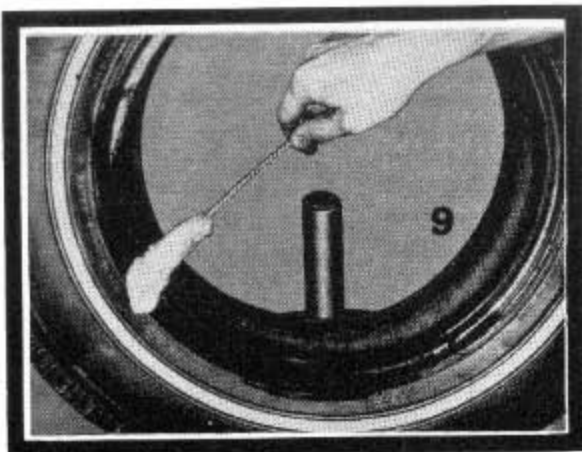

### BOTTOM BEAD

1. Always use a rubber lubricant on both top and bottom beads. See Fig. 9.  
Note: If tube is used, insert tube in casing, apply air to round out tube. Apply rubber lubricant to exposed tube surface.
2. Place tire loosely on rim, but do not force bottom bead into rim well before placing hook end of combination tool.
3. Place the hook end of the combination tool between the lower bead and top of the rim with the hook over the wheel rim flange as shown in Fig. 10. Move hands to opposite end of tool and pull tool in clockwise direction. If tire rotates with tool, hold tire with left hand while pulling on tool.

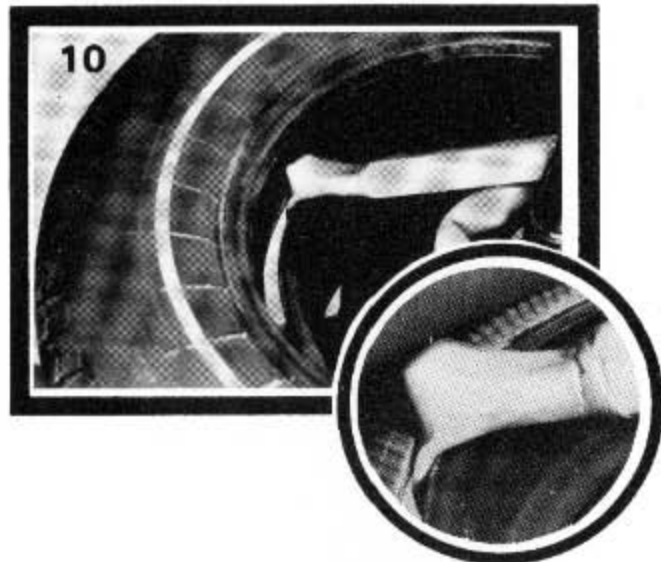

### TOP BEAD

The top bead is mounted in a similar manner to the bottom bead as described above. See Fig. 11.

### INFLATION

Loosen hold down cone and inflate tire. See Fig. 12.

**KEEP YOUR ENTIRE BODY BACK AWAY FROM THE TIRE WHILE INFLATING.**

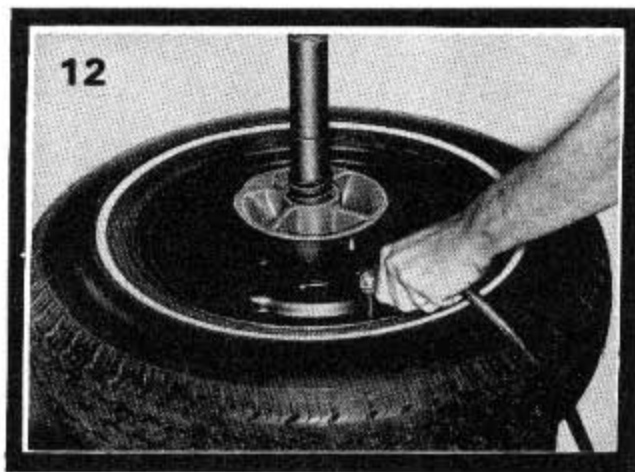
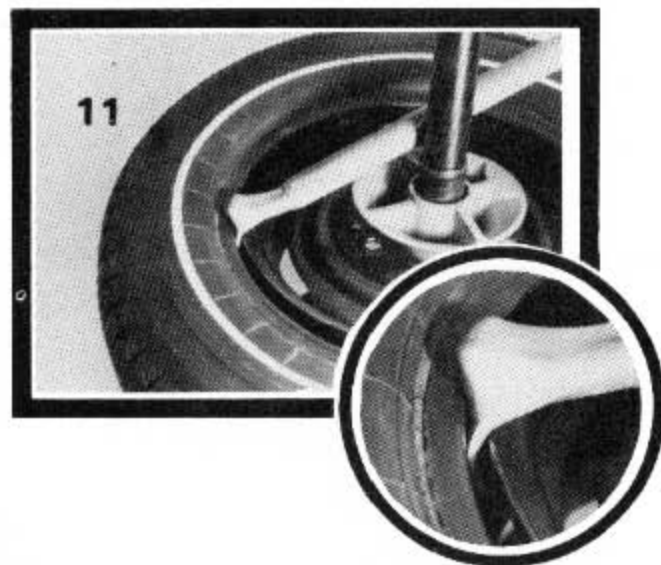

# COATS®

# 310



This Parts List is for  
units with

Serial No. 06657 and up

Manufactured by The Coats Company  
1601 J. P. Hennessy Drive  
La Vergne, TN. 37086  
PHONE: 615-793-7533  
TWX: 810-380-4372

**ORDER PARTS FROM YOUR DISTRIBUTOR OR JOBBER**

REF. NO.	PART NO.	DESCRIPTION	REF. NO.	PART NO.	DESCRIPTION
1	000433	Hold Down Cone	18	106622	Adjusting Strut Weldment
2	106602	Table Top Weldment	19	106626	Ratchet Handle Casting
3	101343	Positioning Pin	20	106634	Locking Bar
4	102928	Cotter Pin	21	107406	Pivot Shaft
5	100952	Positioning Pin Spring	22	103814	3/8" x 1 1/2" Cap Screw
6	010027	1/2" Washer	23	102937	3/8" Lock Nut
7	106620	Pivot Pin (Short)	24	106628	Handle Weldment
8	101181	3/16" x 1" Roll Pin	25	106631	Shoe Weldment
9	107139	Hitch Pin	26	106627	Manual Bead Loosening Assy.
10	106300	3/8" Self Tapping Bolt (ea.)	27	107156	Combo Tool
12	106601	Chassis Weldment	28	108059	Inflation Warning Decal
13	101001	Snap Ring (ea.)	29	106953	3/8" - 12 Hex Head Bolt-Black
14	106619	Center Post Bolt 3/4" x 1 3/4"	37	108017	Warning Decal
15	100994	Washer	38	106621	Pivot Pin (long)
16	106618	Nest Channel	39	107423	Combo Tool Protector Set (6 mount & dismount)
17	106303	3/8" Lock Nut (ea.)			

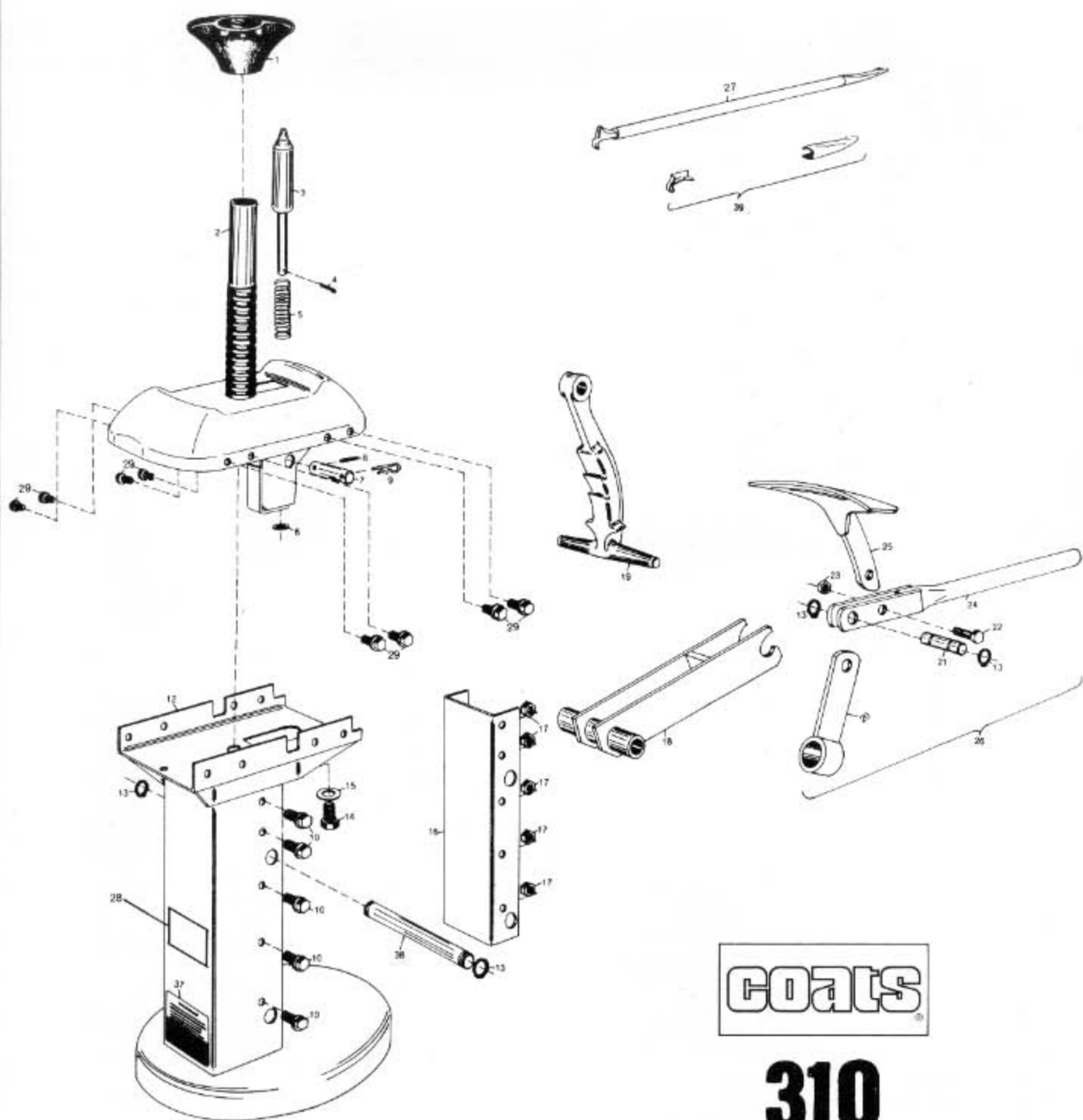

**COATS**

**310**